

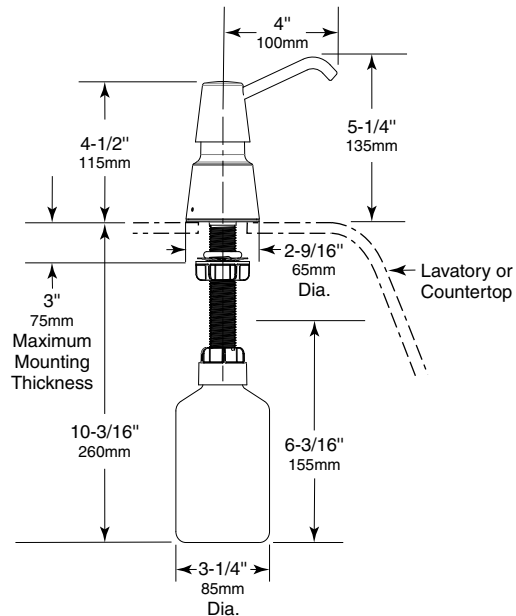

**Technical Data**

# TOP-FILL COUNTER-MOUNTED MANUAL FOAM SOAP DISPENSER

# B-8231



### MATERIALS:

**Spout** — Type-304 stainless steel with bright polished finish.

**Cover Shell** — High polished deep drawn stainless steel.

**Cover Spacer** — Rigid, impact-resistant Acetal.

**Escutcheon** — Chrome-plated, high-impact-resistant ABS with bright polished finish. Concealed locking mechanism.

**Integrated Funnel** — Red polypropylene plastic.

**Body, Foam Pump and Shank** — High-impact-resistant Acetal.

**Valve** — High impact resistant Acetal cylinder & piston. Stainless steel springs.

**Container** — Translucent, shatter-resistant polyethylene. Capacity: 20-fl oz (0.6-L).

### OPERATION:

Press down on Cover Shell to dispense commercially marketed all-purpose foam soaps. Vandal-resistant spout can rotate 360° without damage to unit. Valve operates with one hand, without tight grasping, pinching, or twisting of the wrist, and with less than 5 pounds of force (22.2 N) to comply with accessible design guidelines (including ADA standards in U.S.A.). Escutcheon locks to body with concealed locking mechanism that is opened with special key provided. To fill with foam soap only from top, unlock cover and Foam Dispensing assembly. Unit may also be filled by removing container from below counter.

*Designer's Note:* Bobrick foam soap dispensers are designed to dispense commercially marketed all-purpose foam hand soaps.

### INSTALLATION:

Unit is designed for installation in 1" (25mm) diameter hole in porcelain-enameled steel, cast-iron or vitreous-china lavatories, as well as in countertops adjacent to lavatories. Unit may be mounted in unused faucet hole or through special hole requisitioned when counter is ordered from manufacturer (specify punching location). Shank accommodates maximum 3" (76mm) mounting thickness and can be cut in the field. Clearance required for container diameter is 3-3/8" (85mm).

### SPECIFICATION:

Top-fill counter-mounted manual foam soap dispenser shall dispense 7ml of foam using 0.5ml of commercially marketed foam soaps. Cover shall be constructed of durable high polished deep drawn stainless steel with bright polish finish. Spout assembly shall be Type-304 stainless steel with bright polished finish. Dispenser shall be equipped with integrated funnel to facilitate re-filling of soap. Spout shall rotate 360° without damage to valve mechanism. Valve shall be operable with one hand and with less than 5 pounds of force (22.2 N) to comply with accessible design (including ADA standards in U.S.A.). Escutcheon shall lock to body with concealed locking mechanism that is opened with special key provided. Foam Dispensing assembly shall be removable from top for filling and maintenance. Shank shall accommodate mounting thicknesses up to 3" (76mm). Translucent, shatter-resistant polyethylene container shall have a capacity of 20-fl oz (0.6-L).

**Top-Fill Counter-Mounted Manual Foam Soap Dispenser shall be Model B-8231 of Bobrick Washroom Equipment, Inc., Clifton Park, New York; Jackson, Tennessee; Los Angeles, California; Bobrick Washroom Equipment Company, Scarborough, Ontario; Bobrick Washroom Equipment Pty. Ltd., Australia; and Bobrick Washroom Equipment Limited, United Kingdom.**